

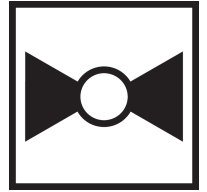

5-year warranty



Technical data

| | | |
|---------------------------|--------------------------------|---|
| Functional data | Valve Size | 3" [80] |
| | Fluid | chilled or hot water, up to 60% glycol |
| | Fluid Temp Range (water) | 0...212°F [-18...100°C] |
| | Body Pressure Rating | 400 psi |
| | Close-off pressure Δ ps | 100 psi |
| | Flow characteristic | equal percentage |
| | Servicing | maintenance-free |
| | Flow Pattern | 2-way |
| | Leakage rate | 0% for A – AB |
| | Controllable flow range | 75° |
| | Cv | 70 |
| | Body pressure rating note | 400 psi |
| | Cv Flow Rating | A-port: as stated in chart B-port: 70% of A – AB Cv |
| Materials | Valve body | Nickel-plated brass body |
| | Stem seal | EPDM (lubricated) |
| | Seat | PTFE |
| | Pipe connection | NPT female ends |
| | O-ring | EPDM (lubricated) |
| | Ball | stainless steel |
| Suitable actuators | Non-Spring | ARB(X) |

Safety notes



- **WARNING:** This product can expose you to lead which is known to the State of California to cause cancer and reproductive harm. For more information go to www.p65warnings.ca.gov

Product features

Application This valve is typically used in air handling units on heating or cooling coils, and fan coil unit heating or cooling coils. Some other common applications include Unit Ventilators, VAV box re-heat coils and bypass loops. This valve is suitable for use in a hydronic system with variable flow.

Flow/Mounting details

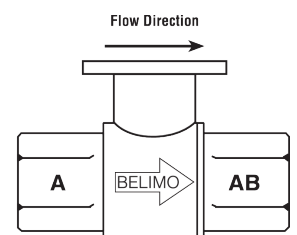
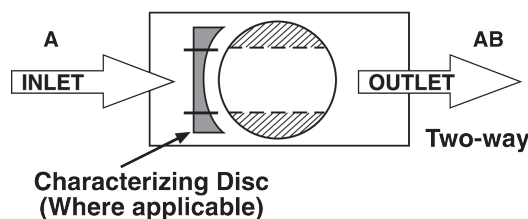

Dimensions

Dimensional drawings

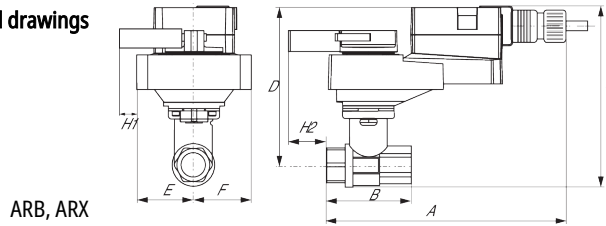

ARB, ARX

| A | B | C | D | E | F | H1 |
|-------------|------------|------------|------------|-----------|-----------|-----------|
| 10.1" [257] | 5.8" [148] | 8.5" [217] | 6.0" [152] | 2.8" [71] | 2.8" [71] | 2.1" [53] |

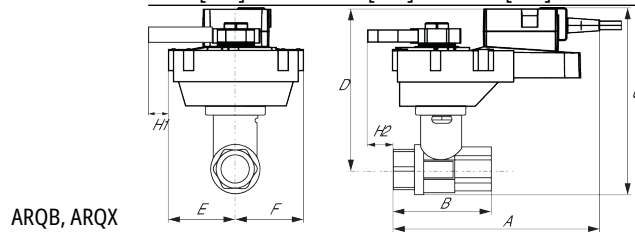

ARQB, ARQX

| A | B | C | D | E | F | H1 | H2 |
|------------|------------|------------|------------|-----------|-----------|-----------|-----------|
| 9.9" [251] | 4.2" [107] | 8.6" [219] | 6.1" [155] | 2.3" [58] | 2.3" [58] | 0.8" [20] | 0.6" [15] |

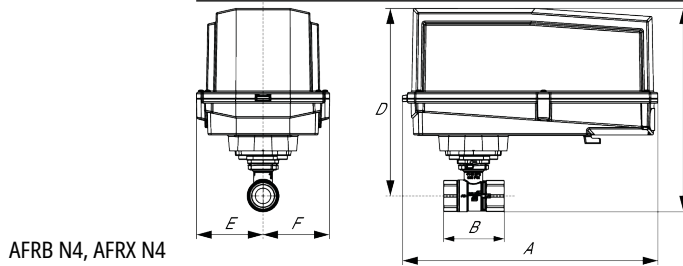

AFRB N4, AFRX N4

| A | B | C | D | E | F |
|-------------|------------|-------------|------------|-----------|-----------|
| 13.0" [330] | 5.8" [148] | 10.3" [262] | 9.3" [235] | 3.4" [86] | 3.4" [86] |

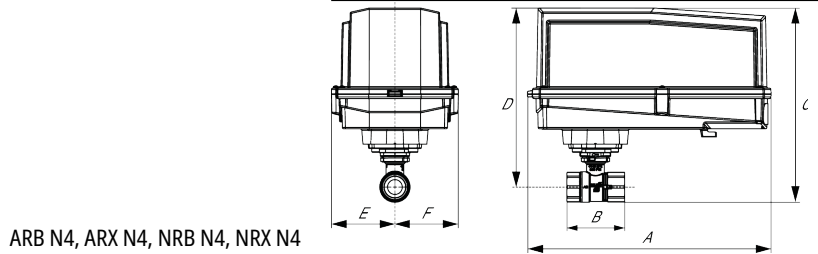

ARB N4, ARX N4, NRB N4, NRX N4

| A | B | D | E | F |
|-------------|------------|------------|-----------|-----------|
| 11.4" [289] | 5.8" [148] | 8.0" [203] | 3.1" [80] | 3.1" [80] |

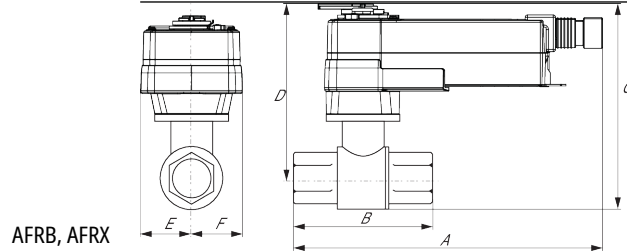

AFRB, AFRX

| A | B | C | D | E | F |
|-------------|------------|------------|------------|-----------|-----------|
| 11.8" [299] | 5.8" [148] | 9.1" [231] | 6.6" [168] | 2.0" [51] | 2.0" [51] |



5-year warranty



Technical data

| | | |
|------------------------|------------------------------------|--|
| Electrical data | Nominal voltage | AC/DC 24 V |
| | Nominal voltage frequency | 50/60 Hz |
| | Power consumption in operation | 7.5 W |
| | Power consumption in rest position | 3 W |
| | Transformer sizing | 10 VA (class 2 power source) |
| | Electrical Connection | 18 GA appliance cable, 3 ft [1 m], with 1/2" conduit connector |
| | Overload Protection | electronic throughout 0...95° rotation |
| Functional data | Operating range Y | 0...135 Ω |
| | Operating range Y note | Honeywell Electronic Series 90, input 0...135 Ω |
| | Position feedback U | 2...10 V |
| | Position feedback U note | Max. 0.5 mA |
| | Position feedback U variable | VDC variable |
| | Direction of motion motor | selectable with switch |
| | Direction of motion fail-safe | reversible with cw/ccw mounting |
| | Manual override | 5 mm hex crank (3/16" Allen), supplied |
| | Angle of rotation | 90° |
| | Running Time (Motor) | default 150 s, variable 70...220 s |
| | Running time motor variable | 70...220 s |
| | Running time fail-safe | <20 s tamb = 68°F [20°C] |
| | Angle of rotation adaptation | off (default) |
| | Noise level, motor | 45 dB(A) |
| Noise level, fail-safe | 62 dB(A) | |
| Position indication | Mechanical | |
| Safety data | Degree of protection IEC/EN | IP54 |
| | Degree of protection NEMA/UL | NEMA 2 UL Enclosure Type 2 |
| | Agency Listing | cULus acc. to UL60730-1A/-2-14, CAN/CSA E60730-1:02, CE acc. to 2014/30/EU and 2014/35/EU; Listed to UL 2043 - suitable for use in air plenums per Section 300.22(c) of the NEC and Section 602.2 of the IMC |
| | Quality Standard | ISO 9001 |
| | Ambient temperature | -22...122°F [-30...50°C] |
| | Storage temperature | -40...176°F [-40...80°C] |
| | Ambient humidity | max. 95% r.H., non-condensing |
| | Servicing | maintenance-free |
| | Weight | Weight |
| Materials | Housing material | Galvanized steel and plastic housing |

| Gateways | Description | Type |
|---------------|---|---------|
| | Gateway MP to BACnet MS/TP | UK24BAC |
| | Gateway MP to LonWorks | UK24LON |
| | Gateway MP to Modbus RTU | UK24MOD |
| Service tools | Description | Type |
| | Connection cable 10 ft [3 m], A: RJ11 6/4 ZTH EU, B: 3-pin Weidmüller and supply connection | ZK4-GEN |
| | Service Tool, with ZIP-USB function, for parametrisable and communicative Belimo actuators, VAV controller and HVAC performance devices | ZTH US |

Electrical installation

✂ INSTALLATION NOTES

- ▲1 Provide overload protection and disconnect as required.
- ▲3 Actuators may also be powered by 24 VDC.
- ▲22 Actuators and controller must have separate transformers.
- ▲23 Consult controller instruction data for more detailed information.
- ▲24 Resistor value depends on the type of controller and the number of actuators. No resistor is used for one actuator. Honeywell® resistor kits may also be used.
- ▲25 To reverse control rotation, use the reversing switch.
- ▲46 Actuators may be controlled in parallel. Current draw and input impedance must be observed.
- ◆ Meets cULus requirements without the need of an electrical ground connection.
- ▲! **Warning! Live Electrical Components!**
During installation, testing, servicing and troubleshooting of this product, it may be necessary to work with live electrical components. Have a qualified licensed electrician or other individual who has been properly trained in handling live electrical components perform these tasks. Failure to follow all electrical safety precautions when exposed to live electrical components could result in death or serious injury.

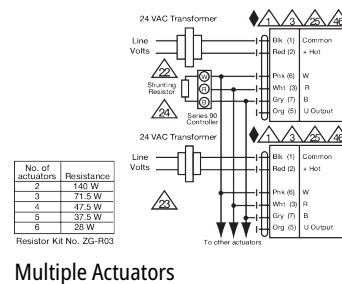
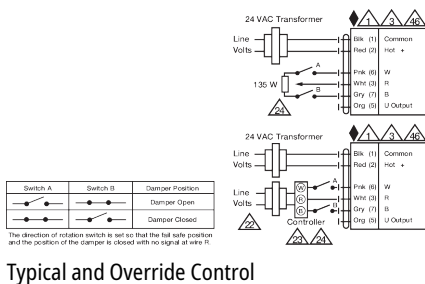
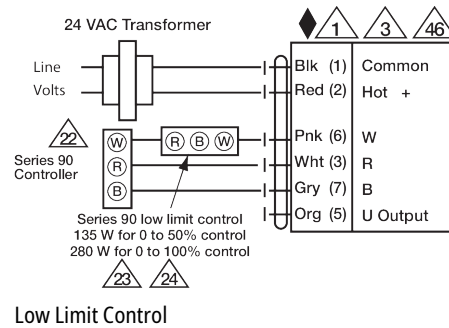
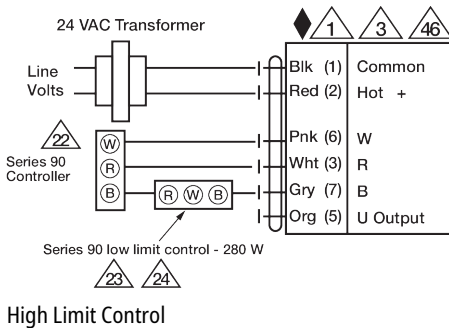

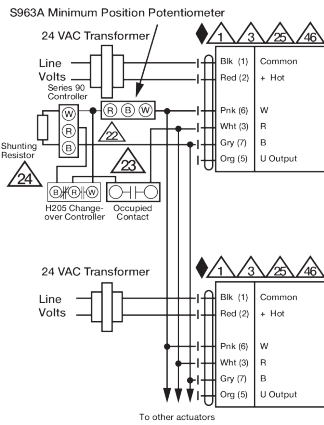

Multiple Actuators with Minimum Position Potentiometer

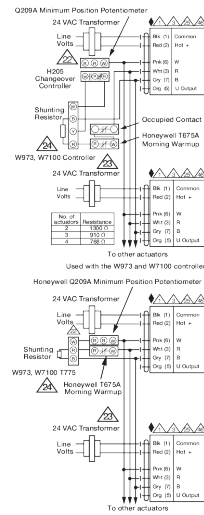

Multiple Actuators Used with W973, W7100 and T775